





LBS

LIGHT BAND SYSTEM



SHOWROOM SARTORIO - MILANO
PHOTO MARCO REGGI



LBS

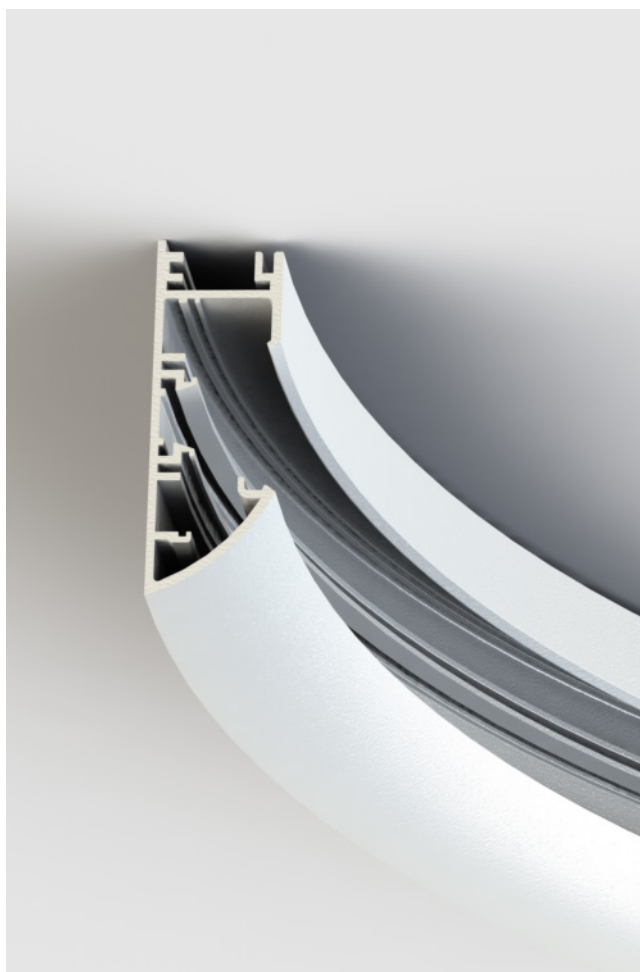
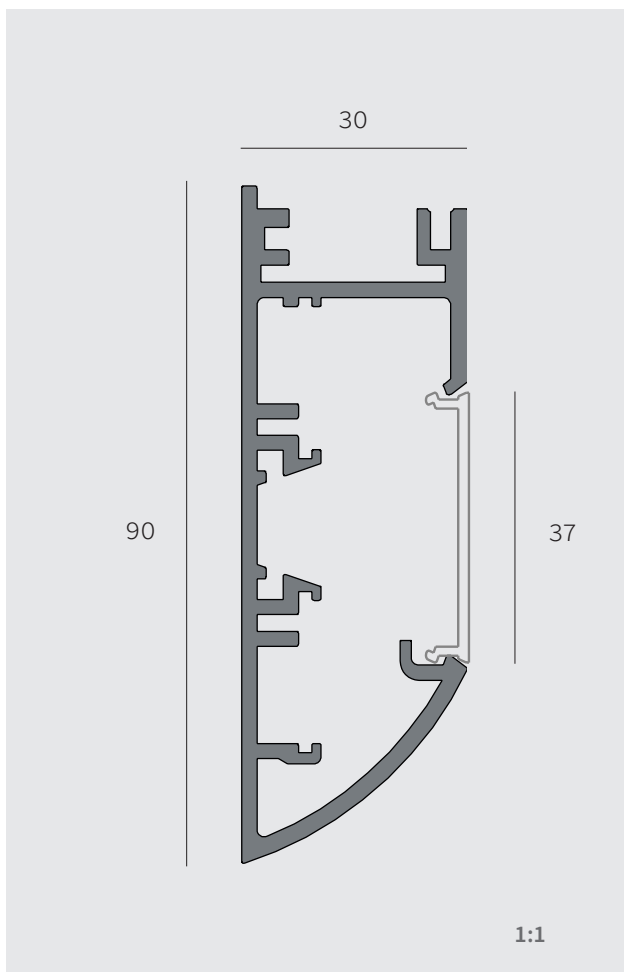

SEZIONE PROFILO/SECTION PROFILE

LBS

Famiglia di profili curvi in estruso di alluminio di 90 x 30 mm, disponibili come moduli finiti in versione a sospensione, a soffitto, parete e ad incasso trimless. Possibilità di scelta tra emissione luminosa perimetrale, diretta e indiretta. Diffusore in policarbonato opalino bianco. Integrabile con proiettori orientabili da agganciare al profilo, completi di sorgente led chip on board e driver remoto. Grado di protezione IP40/IP43. Disponibile in moduli finiti o sistema modulare.

Family of curved extruded aluminum profiles of 90 x 30 mm, available as finished modules suspended, ceiling and wall mounted and trimless recessed versions. Possibility to choose between perimetric, direct and indirect light emission. White opal polycarbonate diffuser. It can be integrated with adjustable projectors complete with LED chip on board source and remote driver. IP40 / IP43. Available default modules and modular system.



UK CONFORMITY ASSESSMENT E EUROPEAN CERTIFICATION / UK CONFORMITY ASSESMENT AND EUROPEAN CERTIFICATION



PRODOTTI COSTRUITI CON MATERIALE RICICLABILE / PRODUCTS MADE OF RECYCLABLE MATERIAL



GARANZIA DI 5 ANNI / 5-YEAR WARRANTY

FINITURE/FINISHINGS



01-BIANCO/WHITE 02-NERO/BLACK 36-ORO/GOLD

FINITURE PREMIUM /PREMIUM FINISHINGS

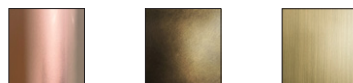

81-ORO ROSA/PINK GOLD 82-BRONZO/BRONZE 83-OTTONE SATINATO/BRUSHED BRASS

KELVIN

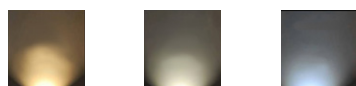

2700°K 3000°K 4000°K

LBS

CURVE FOTOMETRICHE/PHOTOMETRIC DATA

DIFFUSA/DIFFUSED LIGHT

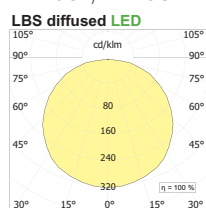

PERIMETRALE/PERIMETRIC LIGHT

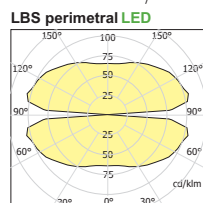

SPOT FOCUS

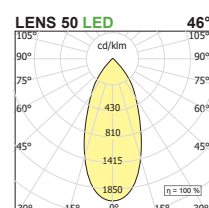
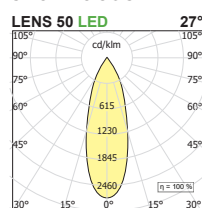



TRIMLESS RECESSED

SUSPENSION PERIMETRIC

WALL

LBS
MODULI FINITI

CURVE ESSE

CEILING DIFFUSED

LBS

/ STAND ALONE MODULES

LBS

INCASSO RECESSED

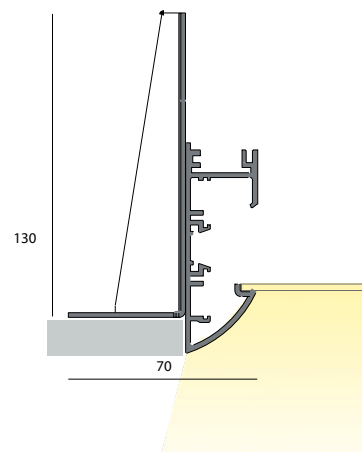

VERSIONI DISPONIBILI/AVAILABLE VERSION

○ **KELVIN**

30 3000K

40 4000K

● **DIMMABLE (OPTIONAL)**

D Dali Touch & Dimm

SU RICHIESTA ON DEMAND

E Versione ad emergenza / Emergency version

D10 Dimmerabile 1-10V / Dimmable 1-10V

CA Sistema di controllo CASAMBI/ CASAMBI control system

/ ## **FINITURA/FINISHING**

□ /01 bianco/white

■ /02 nero/black

/ ## **FINITURA PREMIUM /PREMIUM FINISHING**

■ /81 oro rosa shine/shine pink gold

■ /82 bronzo/ bronze

■ /83 ottone spazzolato/ brushed brass

COMPOSIZIONE CODICE: xxx.x ●●/##

HOW TO CREATE THE CODE: **F1000.827D/01**

CODE

F1000.8 | ● | ● | /## | — finishing

base code | kelvin | dimmable

LBS INCASSO RASATO TRIMLESS RECESSED
LUCE DIRETTA/DIFFUSA/ DIRECT/DIFFUSED EMISSION



taglio per incasso/ recessed hole dimension Ø +3 mm

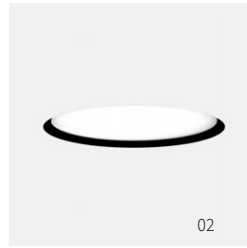
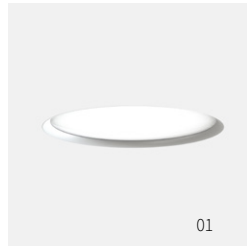
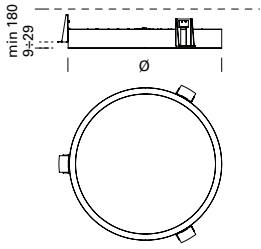

LED W	Ø mm	lm product/3000K	CODE
48	735	3358	LB041.8 ○ ● /##
96	1335	6717	LB042.8 ○ ● /##
168	1335	11754	LB043.8 ○ ● /##

LBS

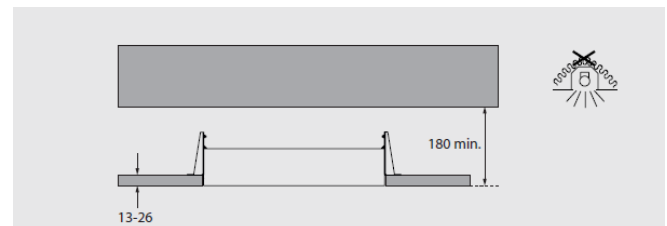
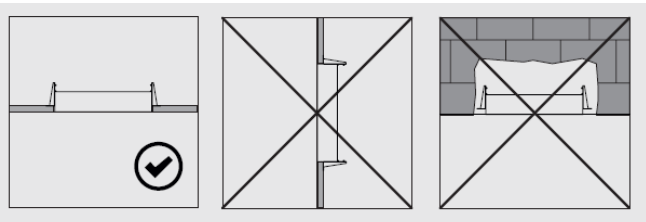



LBS

SOFFITTO CEILING

LUCE PERIMETRALE PERIMETRIC EMISSION

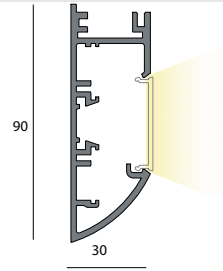

LUCE DIRETTA/DIFFUSA DIRECT/DIFFUSED EMISSION

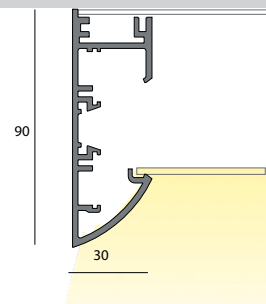

VERSIONI DISPONIBILI/AVAILABLE VERSION

- **KELVIN** ○ **KELVIN**
- 27 2700K 30 3000K
- 30 3000K 40 4000K
- 40 4000K
- TW** Tunable white Dali

- **DIMMABLE (OPTIONAL)**

D Dali Touch & Dimm

SU RICHIESTA ON DEMAND

- E** Versione ad emergenza / Emergency version
- D10** Dimmerabile 1-10V / Dimmable 1-10V
- CA** Sistema di controllo CASAMBI/ CASAMBI control system

/ ## FINITURA/FINISHING

- /01 bianco/white
- /02 nero/black

/ ## FINITURA PREMIUM /PREMIUM FINISHING

- /81 oro rosa shine/shine pink gold
- /82 bronzo/ bronze
- /83 ottone spazzolato/ brushed brass

COMPOSIZIONE CODICE: xxx.x ●●●/##

HOW TO CREATE THE CODE: **F1000.827SD/01**

CODE

F1000.8 ● ● ● /## — finishing

base code kelvin beam dimmable

LBS SOFFITTO LUCE PERIMETRALE CEILING PERIMETRIC EMISSION

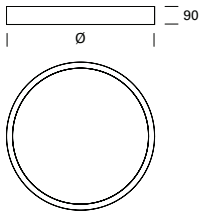

info : Da completare con alimentatore da installare remoto in scatola di derivazione | To be completed with power supply to be installed in a remote junctionbox.

LED W	Ø mm	lm product/3000K	CODE
48	735	5712	LB001.8 ●/##
69	1035	8159	LB002.8 ●/##
90	1335	10605	LB003.8 ●/##

Accessories LB102.9: spot - spot

LBS SOFFITTO LUCE DIRETTA/DIFFUSA CEILING MOUNTED DIRECT/DIFFUSED EMISSION

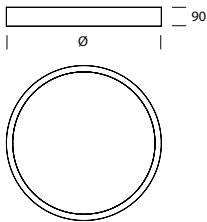

LED W	Ø mm	lm product/3000K	CODE
48	735	3358	LB021.8 ●●/##
96	1035	6717	LB022.8 ●●/##
168	1335	11754	LB023.8 ●●/##

LBS CURVA ESSE S-CURVE

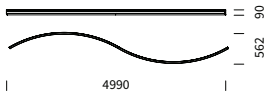

info : Da completare con alimentatore da installare remoto in scatola di derivazione | To be completed with power supply to be installed in a remote junction box

Linea di luce - LED line		W	Dim.	Lmm	lm product/3000K	CODE
87	562	4990	10393	LB210.8 ●/##		

Accessori - Accessories LB102.9: spot - spot

ACCESSORI / ACCESSORIES



LBS SPOT SPOT PROJECTOR



VEDI | SEE PAGE P.99



LBS

SOSPENSIONE SUSPENSION

RISTORANTE LA VELA – TORRE A MARE - BARI
PROJECT LIDIA TREVISANO ARCHITETTO

LUCE PERIMETRALE PERIMETRIC EMISSION

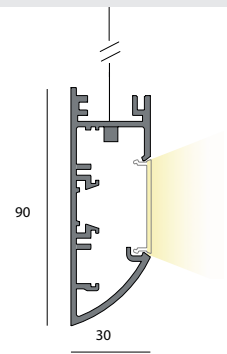

LUCE DIRETTA/DIFFUSA DIRECT/DIFFUSED EMISSION

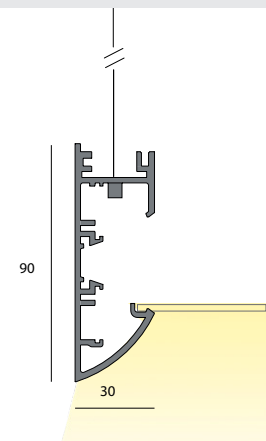

VERSIONI DISPONIBILI/AVAILABLE VERSION

- **KELVIN** ○ **KELVIN**
- 27 2700K 30 3000K
- 30 3000K 40 4000K
- 40 4000K
- TW** Tunable white Dali

● **DIMMABLE (OPTIONAL)**

D Dali Touch & Dimm

SU RICHIESTA ON DEMAND

E Versione ad emergenza / Emergency version

D10 Dimmerabile 1-10V / Dimmable 1-10V

CA Sistema di controllo CASAMBI/ CASAMBI control system

/ ## **FINITURA/FINISHING**

□ /01 bianco/white

■ /02 nero/black

/ ## **FINITURA PREMIUM /PREMIUM FINISHING**

■ /81 oro rosa shine/shine pink gold

■ /82 bronzo/ bronze

■ /83 ottone spazzolato/ brushed brass

/ ## **FINITURA ROSONI /FINISHING CANOPY**

□ /01 bianco/white

■ /02 nero/black

COMPOSIZIONE CODICE: xxx.x ●●/##

HOW TO CREATE THE CODE: **F1000.827D/01**

CODE

F1000.8 ● ● /## — finishing

base code kelvin dimmable

LBS SOSPENSIONE LUCE PERIMETRALE SUSPENSION PERIMETRIC EMISSION

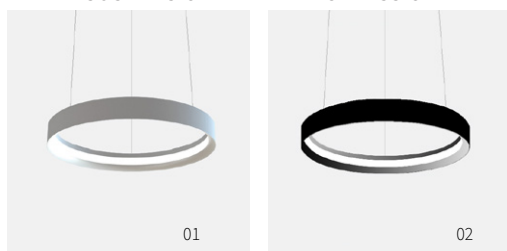
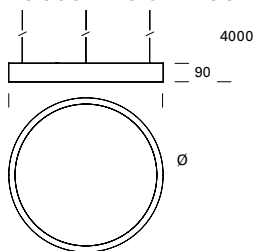

info : Da completare rosone (LB420-LB421-LB428) e cavo di alimentazione (FX05, FX07) | To be completed with power supply (LB420-LB421-LB428), canopy and feed cable (FX05, FX07)

LED W	Ø mm	lm product/3000K	CODE
48	735	5712	LB011.8 ●●/##
69	1035	8159	LB012.8 ●●/##
90	1335	10605	LB013.8 ●●/##

Accessori - Accessories: LB102.9 Spot

LBS SOSPENSIONE LUCE DIRETTA/DIFFUSA DIRECT/DIFFUSED EMISSION

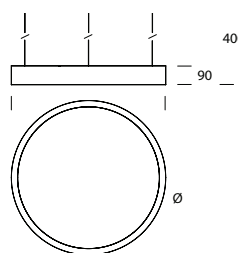

info : Da completare rosone (LB420-LB421-LB428) e cavo di alimentazione (FX05, FX07) | To be completed with power supply (LB420-LB421-LB428), canopy and feed cable (FX05, FX07)

LED W	Ø mm	lm product/3000K	CODE
48	735	3358	LB031.8 ●●/##
96	1035	6717	LB032.8 ●●/##
168	1335	11754	LB033.8 ●●/##

Accessori - Accessories: LB05# Elemento di chiusura Upper finishing element

ACCESSORI / ACCESSORIES

COVER DI CHIUSURA SUPERIORE OPTIONAL UPPER CLOSURE ELEMENT



Ø mm	per codice/for code	CODE
735	LB021-LB031	LB051
1035	LB022-LB032	LB052
1335	LB023-LB033	LB053

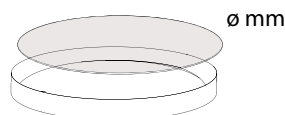

ROSONE CONNESSIONE CANOPY CONNECTION



Kg	Ø mm	CODE
0.11	90	LB420/##



ROSONE PER ALLOGGIAMENTO DRIVER CEILING CANOPY TO HOUSE THE DRIVER

disposizione driver vedi - positioning driver see p.97



Kg	H mm	Ø mm	CODE
0.18	42	271	LB421/##

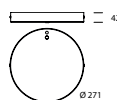

ROSONE PER CARTONGESSO CANOPY FOR PLASTERBOARD CEILING



Kg	taglio/cut	Ø mm	CODE
0.11	⊗ Ø 80	90	LB428/##



CAVO ALIMENTAZIONE POWER CABLE



Dim	L mm	Kg	CODE
2x1,5	4000	,86	FX05.4000/##
4x1,5	4000	3,60	FX07.4000/##

LBS SPOT SPOT PROJECTOR



VEDI | SEE P.99



LBS

PARETE WALL

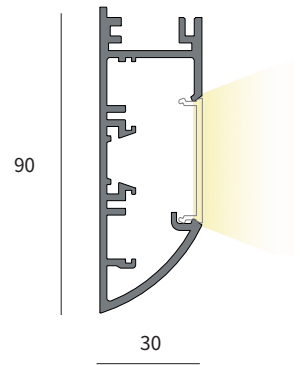

VERSIONI DISPONIBILI/AVAILABLE VERSION

- **KELVIN** ○ **KELVIN**
- 27 2700K 27 2700K
- 30 3000K 30 3000K
- 40 4000K 40 4000K
- TW** Tunable white Dali

● **FASCIO/BEAM**

- F** Flood 27°
- W** Wide 46°

Per i gradi vedere in tabella - For degree check the table

● **DIMMABLE (OPTIONAL)**

- D** Dali Touch & Dimm
- D10** Dimmable 1-10V

/ ## **FINITURA/FINISHING**

- /01 bianco/white
- /02 nero/black

/ ## **FINITURA PREMIUM /PREMIUM FINISHING**

- /81 oro rosa shine/shine pink gold
- /82 bronzo/ bronze
- /83 ottone spazzolato/ brushed brass

COMPOSIZIONE CODICE: xxx.x ●●●/##

HOW TO CREATE THE CODE: **F1000.827SD/01**

CODE



LBS PARETE CON DIFFUSORE INDIRETTO WALL-MOUNTED

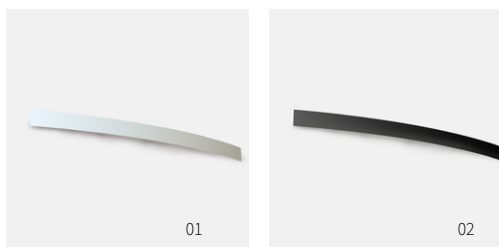
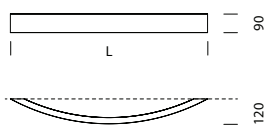

LED W	Dim.	H	Lmm	lm product/3000K	CODE
21	120	90	950	2598	LB201.8 ● /##
34	120	90	1530	3898	LB202.8 ● /##
42	120	90	1945	5197	LB203.8 ● /##

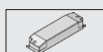

DRIVERS VEDI | SEE P. 447

24V

ACCESSORI / ACCESSORIES

LBS SPOT SPOT PROJECTOR

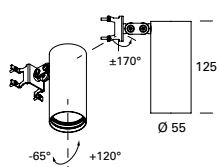

a soffitto
ceiling-mounting

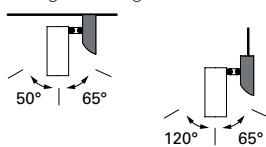

a parete e sospensione wall
and suspension - mounting



LED 48V W	ø mm	Hmm	lm product/beam 3000K		CODE
			F27°	W46°	
12	55	125	1285	1289	LB102.9 ●●● /##
18	55	125	1575	1579	LB103.9 ●●● /##

Installabile su tutti i prodotti a luce perimetrale | suitable to fit in perimetric emission fittings
Accessori - Accessories L055#.A: Lente con anello - lens with ring

LENTI CON ANELLO / LENSES WITH RING

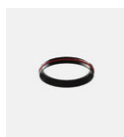

	ø	Kg	CODE
LENTE SATINATA / SATINED LENS	55	0,01	L055S.A /##
LENTE ELISSOIDALE / ELIPSOID LENS	55	0,01	L055E.A /##
LENTE ASIMMETRICA / ASYMMETRIC LENS	55	0,01	L055A.A /##
FILTRO NIDO D'APE / HONEY COMB LOUVER	55	0,01	L055R.A /##

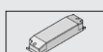

DRIVERS VEDI | SEE P. 447

48V



LBS
SISTEMA / SYSTEM



LBS SISTEMA SOFFITTO CEILING SYSTEM



FARMACIA DALL'AGLIO MONTALDI - REGGIOLO
PROJECT FRANCA PROGETTI

PROFILI - PROFILE

CERCHIO LUCE PERIMETRALE INTERNA RING FOR INTERNAL PERIMETRIC EMISSION

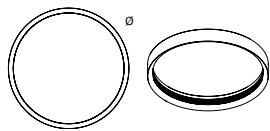

∅ mm
734
1034
1334

CODE
LB301 /##
LB302 /##
LB303 /##

SEMICERCHIO LUCE PERIMETRALE INTERNA HALF-RING FOR INTERNAL PERIMETRIC EMISSION

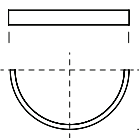

∅ mm.
734
1034
1334

CODE
LB320 /##
LB321 /##
LB322 /##

1/4 DI CERCHIO LUCE INTERNA QUARTER-RING FOR INTERNAL EMISSION

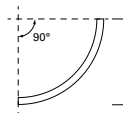

∅ mm.
1034

CODE
LB323 /##

TRATTO RETTILINEO STRAIGHT PROFILE

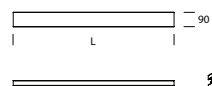
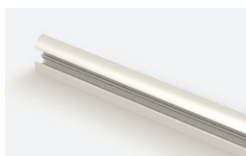

Lmm
1000
2000
3000

CODE
LB340 /##
LB341 /##
LB342 /##

COPPIA DI TESTATE DI CHIUSURA COUPLE OF CLOSURE HEADS

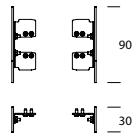

CODE
LB422 /##

GIUNTO INTERNO PER MODULO SOFFITTO INTERNAL JOINT FOR CEILING MODULE

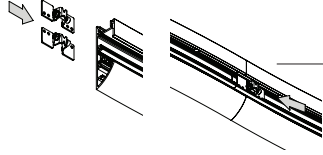

CODE
LB426

SISTEMA DI FISSAGGIO A SOFFITTO CEILING HANGING SYSTEM

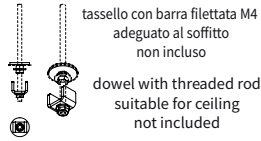

CODE
LB424

DIFFUSORE PERIMETRALE PERIMETRIC DIFFUSER

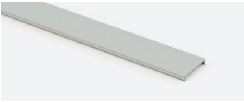

Lmm	CODE
1000	LB431
2000	LB432
3000	LB433

COVER PERIMETRALE VERNICIATO (CIECO) PERIMETRIC SLOT CLOSURE ELEMENT



Lmm	CODE
1000	LB431 /##

/## FINITURA/FINISHING

- /01 bianco/white
- /02 nero/black

/## FINITURA PREMIUM /PREMIUM FINISHING

- /81 oro rosa shine/shine pink gold
- /82 bronzo/ bronze
- /83 ottone spazzolato/ brushed brass

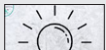

ELEMENTI LUMINOSI /LIGHT ELEMENTS P.98

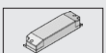

DRIVERS VEDI | SEE P. 447

LBS

SISTEMA SOSPENSIONE / SUSPENSION SYSTEM

PROFILI - PROFILE

CERCHIO LUCE PERIMETRALE INTERNA RING FOR INTERNAL PERIMETRIC EMISSION

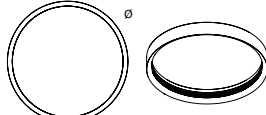
		\varnothing mm 734 1034 1334	CODE LB301 /## LB302 /## LB303 /##
---	---	---	--

SEMICERCHIO LUCE PERIMETRALE INTERNA HALF-RING FOR INTERNAL PERIMETRIC EMISSION

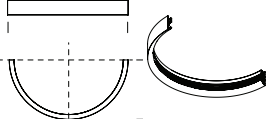
		\varnothing mm. 734 1034 1334	CODE LB320 /## LB321 /## LB322 /##
---	---	--	--

1/4 DI CERCHIO LUCE INTERNA QUARTER-RING FOR INTERNAL EMISSION

		\varnothing mm. 1034	CODE LB323 /##
---	---	---------------------------	--------------------------

TRATTO RETTILINEO STRAIGHT PROFILE

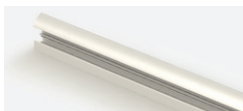
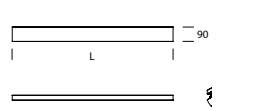
		Lmm 1000 2000 3000	CODE LB340 /## LB341 /## LB342 /##
---	---	-----------------------------	--

COPPIA DI TESTATE DI CHIUSURA COUPLE OF CLOSURE HEADS

		CODE LB422 /##
---	---	--------------------------

GIUNTO SUPERIORE SOLO PER MODULO SOSPENSIONE UPPER JOINT JUST FOR SUSPENSION MODULE

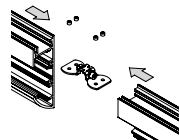

CODE
LB425

GIUNTO CONNESSIONE TRA SOSPENSIONI JOINT TO CONNECT SUSPENSION PERIMETRIC & DIRECT-DIFFUSED EMISSION

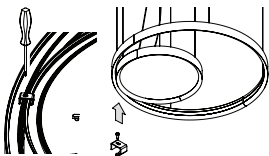

CODE
LB427

CAVO DI ALIMENTAZIONE POWER CORD



Dim.	Kg	CODE Lmm2000	CODE Lmm4000
3X0,75	0.18	LB403.2	LB403.4
5X0,75	0.30	LB405.2	LB405.4
7X0,75	0.30	LB407.2	LB407.4
9X0,75	0.30	LB409.2	LB409.4
2X0,75	0.18		FX05.4000/##
4X0,75	0.30		FX07.4000/##

KIT SOSPENSIONE 1 CAVO ACCIAIO SINGLE STEEL HANGING KIT



Lmm	CODE
2000	LB423.2
4000	LB423.4

DIFFUSORE PERIMETRALE PERIMETRIC DIFFUSER



Lmm	CODE
1000	LB431
2000	LB432
3000	LB433

COVER PERIMETRALE VERNICIATO (CIECO) PERIMETRIC SLOT CLOSURE ELEMENT



Lmm	CODE
1000	LB431 /##

DIFFUSORE INDIRETTO LINEARE INDIRECT LINEAR DIFFUSER

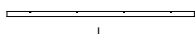

Lmm	CODE
1000	LB447

per LB340 - LB341 - LB342 | for LB340 - LB341 - LB342 | por LB340 - LB341 - LB342

DIFFUSORE INDIRETTO SEMICERCHIO HALF-RING DIFFUSER FOR INDIRECT EMISSION

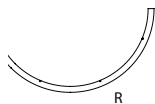

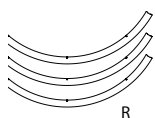

ø mm	PZ/PCS	CODE
734	1 pz	LB444
1034	1 pz	LB445
1334	1 pz	LB446

KIT DIFFUSORE INDIRETTO DIFFUSER KIT FOR INDIRECT EMISSION





ø mm	PZ/PCS	CODE
734	3 pz	LB441.3
1034	3 pz	LB442.3
1334	4 pz	LB443.4

/## FINITURA/FINISHING

-  /01 bianco/white
-  /02 nero/black

/## FINITURA PREMIUM /PREMIUM FINISHING

-  /81 oro rosa shine/shine pink gold
-  /82 bronzo/ bronze
-  /83 ottone spazzolato/ brushed brass



ELEMENTI LUMINOSI /LIGHT ELEMENTS P.98

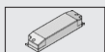

DRIVERS VEDI | SEE P.447



ROSONI DISPONIBILI AVAILABLE CANOPIES

ROSONE CONNESSIONE CANOPY CONNECTION



Kg	ø mm	CODE
0.11	90	LB420/##

ROSONE PER ALLOGGIAMENTO DRIVER CEILING CANOPY TO HOUSE THE DRIVER

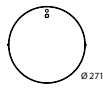



Kg	Hmm	ø mm	CODE
0.18	42	271	LB421/##

ROSONE PER CARTONGESSO CANOPY FOR PLASTERBOARD CEILING



Kg	taglio/cut ø	ø mm	CODE
0.11	80	90	LB428/##

/ ## FINITURA/FINISHING

-  /01 bianco/white
-  /02 nero/black

LBS

DISPOSIZIONE ALIMENTATORI NEL ROSONE

POWER SUPPLIES POSITIONING INTO THE CANOPY ROSE CEILING

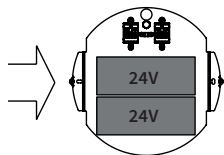
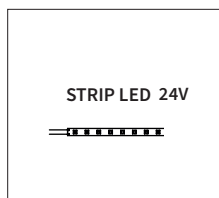

	nr.max
AE50.24V	2
AE75.24V	
AE100.2.24V	
AE150.24VIP	
AE150D.24VIP	
AE100D.24V	1

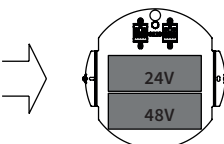
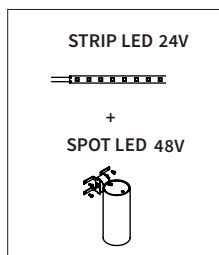

	nr.max
AE50.24V	1
AE75.24V	
AE100.2.24V	
AE150.24VIP	
AE150D.24VIP	
AE50.48V	1
AE75.48V	
AE100.48V	

LBS

ELEMENTI LUMINOSI

LIGHT ELEMENTS



LINEA DI LUCE PER LUCE PERIMETRALE LED LINE FOR PERIMETRIC EMISSION

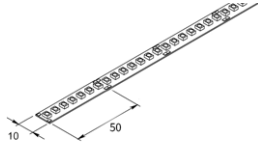

LINEA DI LUCE - LED LINE

W/m	Lcd/m	K	lm/m	lm/W	CRI	IP	Lmm	CODE
22	168	2700	3015	139	80	20	5000	ST22.27.5
22	168	3000	3015	139	80	20	5000	ST22.30.5
22	168	4000	3270	139	80	20	5000	ST22.40.5

LINEA DI LUCE 3D PER LUCE INDIRETTA LED LINE 3D FOR INDIRECT EMISSION

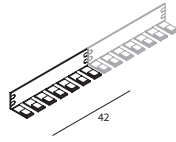

LINEA DI LUCE - LED LINE

W/m	lm/m	K	Kg	Lmm	CODE
22	3015	3000	0,18	5000	ST22.3D30.5
22	3270	4000	0,18	5000	ST22.3D40.5

LBS SPOT SPOT PROJECTOR

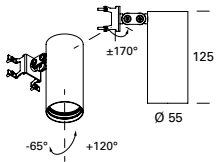

LED48V		lm product/beam 3000K				CODE
W	ø mm	Hmm	F27°	W46°		
12	55	125	1285	1289	LB102.9 ●●●/##	
18	55	125	1575	1579	LB103.9 ●●●/##	

Installabile su tutti i prodotti a luce perimetrale | suitable to fit in perimetric emission fittings
 Accessori - Accessories L055#.A: Lenti con anello - lens with ring

LENTI CON ANELLO / LENSES WITH RING



	ø	Kg	CODE
LENTE SATINATA / SATINED LENS	55	0,01	L055S.A /##
LENTE ELISSOIDALE / ELIPSOID LENS	55	0,01	L055E.A /##
LENTE ASIMMETRICA / ASYMMETRIC LENS	55	0,01	L055A.A /##
FILTRO NIDO D'APE / HONEY COMB LOUVER	55	0,01	L055R.A /##

VERSIONI DISPONIBILI / AVAILABLE VERSION

● **KELVIN**

- 27 2700K
- 30 3000K
- 40 4000K

● **FASCIO / BEAM**

- F** Flood 27°
- W** Wide 46°

Per i gradi vedere in tabella - For degree check the table

● **DIMMABLE (OPTIONAL)**

- D** Dali Touch & Dimm
- D10** Dimmable 1-10V

/ ## **FINITURA / FINISHING**

- /01 bianco/white
- /02 nero/black

/ ## **FINITURA PREMIUM / PREMIUM FINISHING**

- /81 oro rosa shine/shine pink gold
- /82 bronzo/bronze
- /83 ottone spazzolato/brushed brass

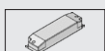

DRIVERS VEDI | SEE P.447