



EX OFFICINE REGGIANE
PROJECT ARCH. ANDREA OLIVA



FIFTY5

STANDARD

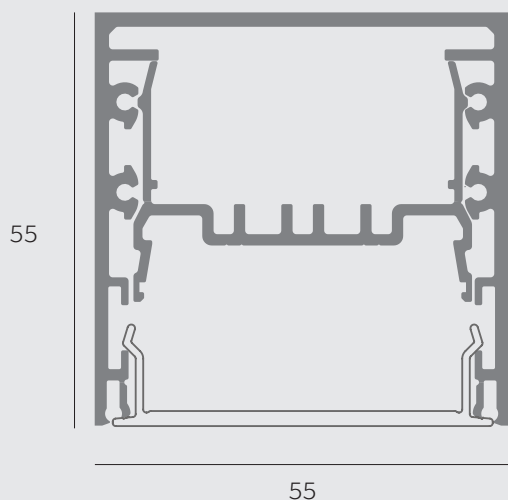

PRO

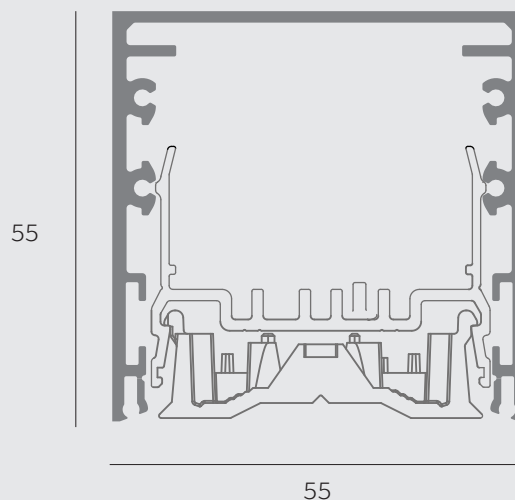

1:1

SEZIONE PROFILO/SECTION PROFILE

FIFTY5

Corpi illuminanti lineari, in estruso di alluminio 55x55mm, per installazione a soffitto, sospensione. Finitura verniciata testurizzata o anodizzata. Schermi per luce diffusa in policarbonato opalino, nella versione PRO sono disponibili ottiche con diverse aperture del fascio ed equipaggiabile, all'occorrenza, con spettri per orticoltura. IP40/IP43. Disponibile in moduli finiti o sistema modulare.

Linear lighting fixtures, in extruded aluminum 55x55mm, for ceiling, suspension. Embossed painted finish. Screens for diffused light in opal polycarbonate, for the PRO version are available optics with different beam openings. Might be equipped, if necessary, with spectra for horticulture. IP40 / IP43. Available default modules and modular system.



UK CONFORMITY ASSESSMENT E EUROPEAN CERTIFICATION /
UK CONFORMITY ASSESSMENT AND EUROPEAN CERTIFICATION



PRODOTTI COSTRUITI CON MATERIALE RICICLABILE / PRODUCTS MADE OF RECYCLABLE MATERIAL



GARANZIA DI 5 ANNI / 5-YEAR WARRANTY



VERSIONI HORTICULTURE/AVAILABLE HORTICULTURE VERSION

Possibilità di montare lampade adatte alla crescita delle piante indoor / Horticulture version suitable for growth indoor. Il tocco green di Lucifero's. I profili File hanno la possibilità di essere equipaggiati con spettri di luce adatti all'orticoltura. L'illuminazione adatta al verde converte l'energia elettrica in fotoni che stimolano la fotosintesi delle piante anche in assenza di luce naturale. La presenza delle piante conferisce agli ambienti, siano essi abitazioni o ambienti di lavoro, un'atmosfera di qualità: i rumori vengono attutiti, l'aria viene ossigenata e la concentrazione aumenta. Le piante hanno effetti benefici anche a livello psicologico attenuando lo stress e aumentando la produttività lavorativa.



TUNABLE WHITE / TUNABLE WHITE



DIFFUSORE OPAL / OPAL DIFFUSER

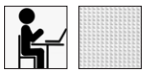

DIFFUSORE MICROPRISMATICO A LUMINANZA CONTROLLATA /

MICROPRISMATIC DIFFUSER CONTROLLED LUMINANCE
(CONFORME ALLA NORMATIVA EN 12464-1) / (CONFORM TO STANDARD EN 12464-1)

File può essere equipaggiato con un diffusore microprismatico in alternativa al diffusore standard opalino. Questa versione rende File ideale per ambienti di lavoro ove sia necessaria una bassa luminanza, una migliore distribuzione della luce ed un effetto anti riflesso.

A completare la collezione c'è la versione Tunable White che grazie alla sua dimmerazione permette di regolare l'intensità luminosa con il variare delle ore del giorno in perfetta sintonia con il ritmo circadiano, sincronizzandosi con il ciclo naturale del giorno e della notte.

FINITURE/FINISHINGS



01-BIANCO/WHITE



02-NERO/BLACK



49-MOKA/MOKA

FINITURE PREMIUM /PREMIUM FINISHINGS



81-ORO ROSA/
PINK GOLD



82-BRONZO/
BRONZE



83-OTTONE SATINATO /
BRUSHED BRASS

KELVIN



2700°K



3000°K



4000°K

CURVE FOTOMETRICHE/PHOTOMETRIC DATA

OPTICS FIFTY5 STANDARD

DF Diffused

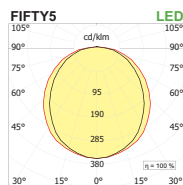
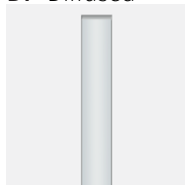

OPTICS FIFTY5 PRO

NR Narrow 30°

WI 60° UGR < 19

DF Diffused

SA Asym

DA Double Asym

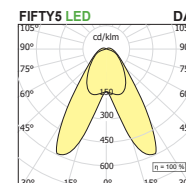
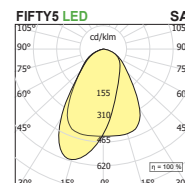
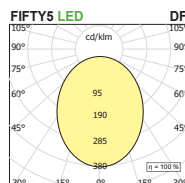
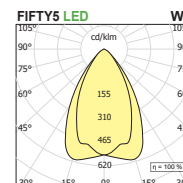
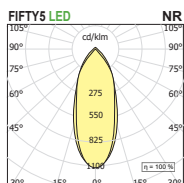
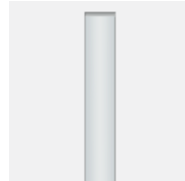

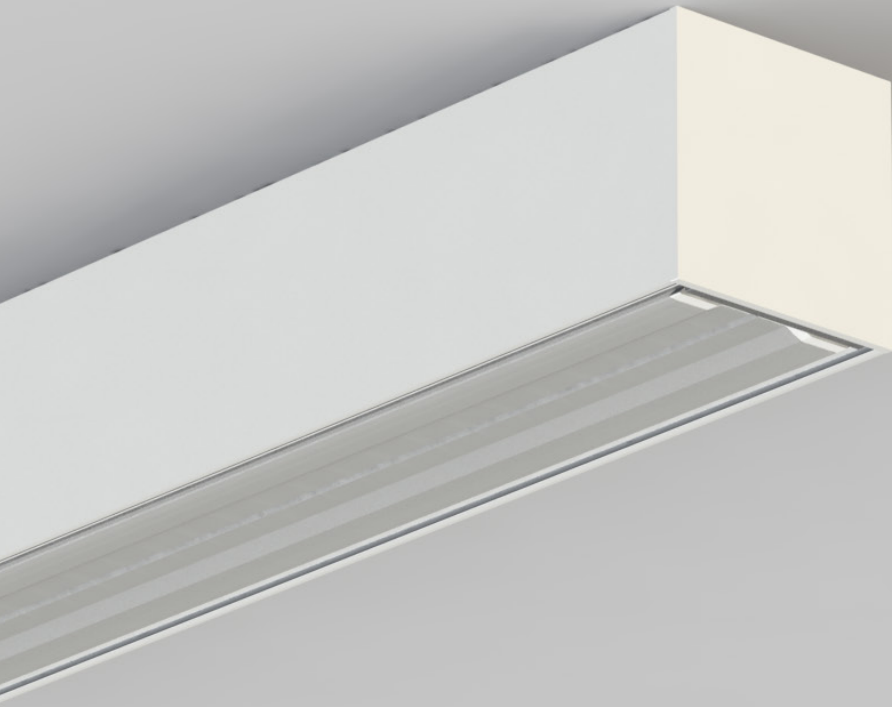

FIFTY5

SOFFITTO CEILING

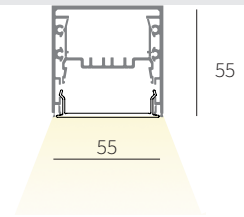

VERSIONI DISPONIBILI/AVAILABLE VERSION

● KELVIN

27 2700K

30 3000K

40 4000K

TW Tunable White Dali*

○ KELVIN

27 2700K

30 3000K

40 4000K

HC Horticulture

TW Tunable White Dali*

*Note: Disponibile per le seguenti misure: 1142, 1702, 2262mm. Gli apparecchi con temperatura di colore variabile (Tunable White) vengono forniti comprensivi di alimentatore DALI. / Available for the following sizes: 1142, 1702, 2262mm. Luminaires with variable colour temperature (Tunable White) are delivered complete with DALI power supply.

● FASCIO/BEAM

NR Narrow 20°

WI Wide 60° UGR<19

DF Diffused

SA Asymmetric

DA Double Asymmetric

● DIMMABLE (OPTIONAL)

D Dali Touch & Dimm

SU RICHIESTA ON DEMAND

E Versione ad emergenza / Emergency version

D10 Dimmerabile 1-10V / Dimmable 1-10V

CA Sistema di controllo CASAMBI / CASAMBI control system

/ ## FINITURA / FINISHING



/01 bianco/white



/02 nero/black



/49 moka/moka

/ ## FINITURA PREMIUM /PREMIUM FINISHING



/81 oro rosa shine/shine pink gold



/82 bronzo/ bronze



/83 ottone spazzolato/ brushed brass

COMPOSIZIONE CODICE: xxx.x ●●●/##

HOW TO CREATE THE CODE: F1000.827SD/01

CODE

F1000.8 ● ● ● /## — finishing
 | | | |
 base code kelvin beam dimmable

FIFTY5 STANDARD



SOFFITTO COMPLETO DI SCHERMO DIFFONDENTE OPALINO CEILING MOUNTED DIFFUSER OPALINE INCLUDED

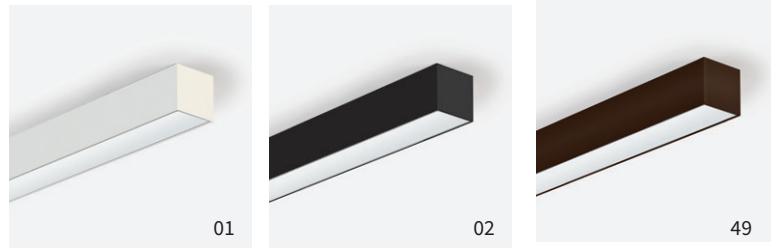
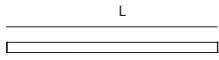

| LED | W | L.mm | Kg | lm product 3000K | CODE |
|-----|------|------|------|------------------|------------------------|
| | 19,2 | 862 | 1,30 | 1082 | FT112.8 ●●● /## |
| | 25,6 | 1142 | 1,92 | 1442 | FT113.8 ●●● /## |
| | 32 | 1422 | 2,10 | 1803 | FT114.8 ●●● /## |
| | 38,4 | 1702 | 2,30 | 2163 | FT115.8 ●●● /## |
| | 44,8 | 1982 | 3,00 | 2524 | FT116.8 ●●● /## |
| | 51,2 | 2262 | 3,30 | 2884 | FT117.8 ●●● /## |

DF Diffused

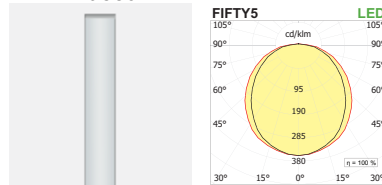

FIFTY5PRO



SOFFITTO CEILING MOUNTED

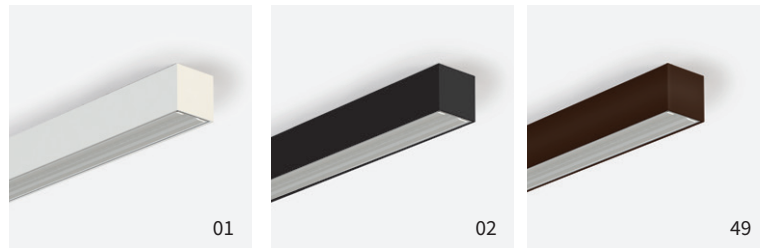
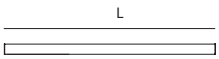

| LED | Dim. | L.mm | NR | WI | DF | SA | DA | CODE |
|-----|------|-------|------|------|------|------|------|-----------------------------|
| | 46,8 | 55X55 | 1142 | 6355 | 6497 | 6088 | 6292 | 6355 FT013.9 ●●● /## |
| | 70,2 | 55X55 | 1702 | 9532 | 9746 | 9131 | 9438 | 9532 FT015.9 ●●● /## |

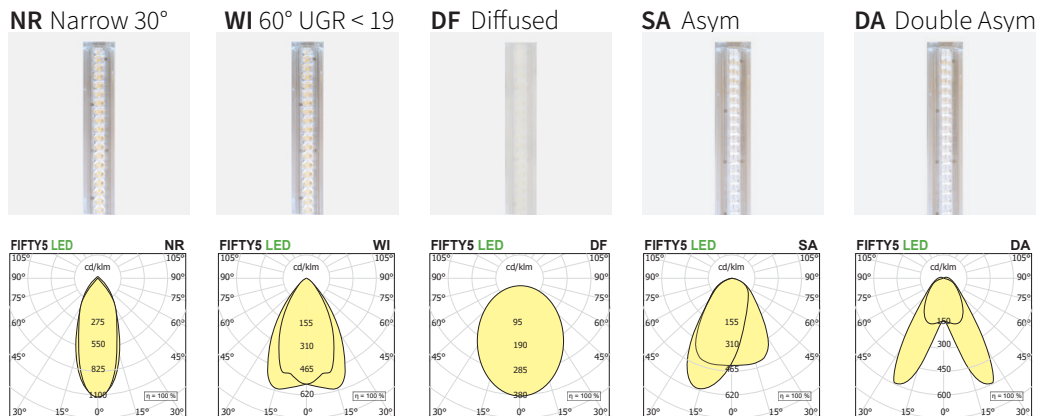

FIFTY5



FIFTY5

SOSPENSIONE SUSPENSION

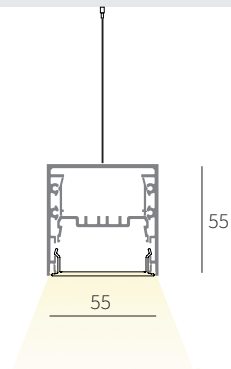

VERSIONI DISPONIBILI/AVAILABLE VERSION

● KELVIN

- 27 2700K
- 30 3000K
- 40 4000K
- TW Tunable White Dali*

○ KELVIN

- 27 2700K
- 30 3000K
- 40 4000K
- HC Horticulture
- TW Tunable White Dali*

*Note: Disponibile per le seguenti misure: 1142, 1702, 2262mm. Gli apparecchi con temperatura di colore variabile (Tunable White) vengono forniti comprensivi di alimentatore DALI. / Available for the following sizes: 1142, 1702, 2262mm. Luminaires with variable colour temperature (Tunable White) are delivered complete with DALI power supply.

● FASCIO/BEAM

- NR Narrow 20°
- WI Wide 60° UGR<19
- DF Diffused
- SA Asymmetric
- DA Double Asymmetric



● DIMMABLE (OPTIONAL)

- D Dali Touch & Dimm



SU RICHIESTA ON DEMAND

- E Versione ad emergenza / Emergency version
- D10 Dimmerabile 1-10V / Dimmable 1-10V
- CA Sistema di controllo CASAMBI / CASAMBI control system

/ ## FINITURA / FINISHING

-  /01 bianco/white
-  /02 nero/black
-  /49 moka/moka

/ ## FINITURA PREMIUM /PREMIUM FINISHING

-  /81 oro rosa shine/shine pink gold
-  /82 bronzo/ bronze
-  /83 ottone spazzolato/ brushed brass

COMPOSIZIONE CODICE: xxx.x●●●/##

HOW TO CREATE THE CODE: F1000.827SD/01



FIFTY5 STANDARD

SOSPENSIONE COMPLETO DI SCHERMO DIFFONDENTE OPALINO
SUSPENSION MOUNTED DIFFUSER OPALINE INCLUDED

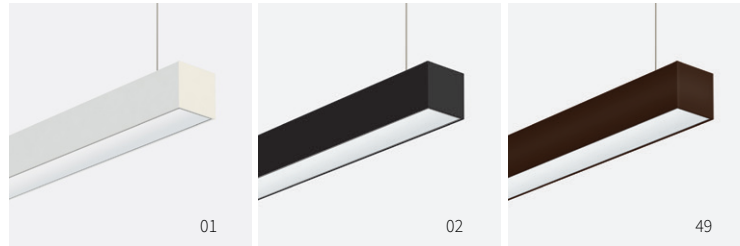
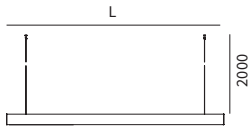

| LED | W | L.mm | Kg | lm product 3000K | CODE |
|-----|------|------|------|------------------|------------------------|
| | 19,2 | 862 | 1,56 | 1082 | FT122.8 ●●● /## |
| | 25,6 | 1142 | 1,94 | 1442 | FT123.8 ●●● /## |
| | 32 | 1422 | 2,40 | 1803 | FT124.8 ●●● /## |
| | 38,4 | 1702 | 2,70 | 2163 | FT125.8 ●●● /## |
| | 44,8 | 1982 | 3,25 | 2524 | FT126.8 ●●● /## |
| | 51,2 | 2262 | 3,76 | 2884 | FT127.8 ●●● /## |

DF Diffused

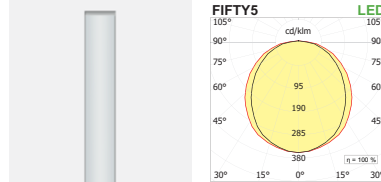

FIFTY5PRO

SOSPENSIONE SUSPENSION MOUNTED

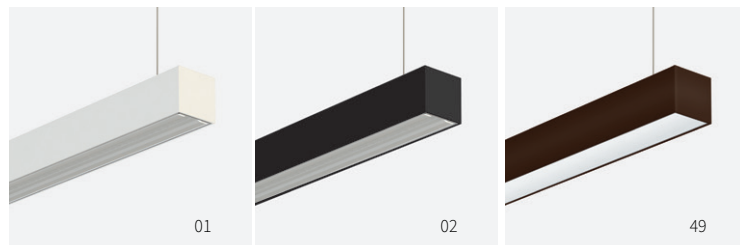
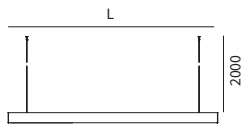

| LED | W | Dim. | L.mm | NR | WI | DF | SA | DA | CODE |
|-----|------|-------|------|------|------|------|------|------|------------------------|
| | 46,8 | 55X55 | 1142 | 6355 | 6497 | 6088 | 6292 | 6355 | FT023.9 ●●● /## |
| | 70,2 | 55X55 | 1702 | 9532 | 9746 | 9131 | 9438 | 9532 | FT025.9 ●●● /## |

NR Narrow 30°

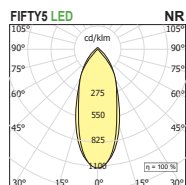

WI 60° UGR < 19

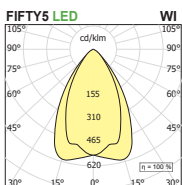

DF Diffused

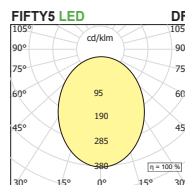
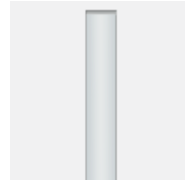

SA Asym

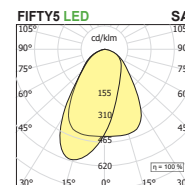

DA Double Asym

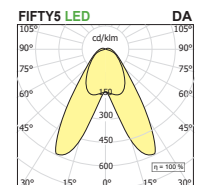

FIFTY5

SOFFITTO SISTEMA CEILING SYSTEM



COMPOSIZIONE CODICE: xxx.x /##

HOW TO CREATE THE CODE: **F1000/01**



CODE

F1000 /## — finishing



|
base code

.misura sostituire con la misura necessaria in mm. /
replace with the required measure in mm.

/## FINITURA/FINISHING

-  /01 bianco/white
-  /02 nero/black
-  /49 moka/moka

/## FINITURA PREMIUM /PREMIUM FINISHING

-  /81 oro rosa shine/shine pink gold
-  /82 bronzo/ bronze
-  /83 ottone spazzolato/ brushed brass

PROFILO VUOTO SOFFITTO / CEILING EMPTY PROFILE



| L.mm | CODE |
|-------|-------------------------|
| 1000 | FT030.1000 /## |
| 2000 | FT030.2000 /## |
| 3000 | FT030.3000 /## |
| ----- | FT030.misura /## |

COPPIA DI TESTATE / COUPLE OF HEADS



CODE
FT040 /##

GIUNTI LINEARI COPPIA / LINEAR JOINT COUPLE



CODE
LT2482

DIFFUSORE POLICARBONATO OPALINO PER VERSIONE STANDARD / OPALINE POLYCARBONATE DIFFUSER FOR STANDARD VERSION

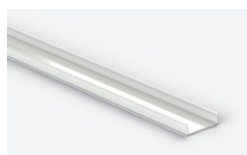

| L.mm | Kg | CODE |
|-------|-------|---------------------|
| 1000 | 0.16 | FT033.1000 |
| 2000 | 0.33 | FT033.2000 |
| 3000 | 0.50 | FT033.3000 |
| ----- | ----- | FT033.misura |



ELEMENTI LUMINOSI /LIGHT ELEMENTS P.113

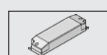

DRIVERS VEDI | SEE P. 447

FIFTY5

SOSPENSIONE SISTEMA

SUSPENSION SYSTEM



COMPOSIZIONE CODICE: xxx.x /##

HOW TO CREATE THE CODE: **F1000/01**



CODE

F1000 /## — finishing



|
base code

.misura sostituire con la misura necessaria in mm. /
replace with the required measure in mm.

/## FINITURA/FINISHING

-  /01 bianco/white
-  /02 nero/black
-  /49 moka/moka

/ ## FINITURA PREMIUM /PREMIUM FINISHING

-  /81 oro rosa shine/shine pink gold
-  /82 bronzo/ bronze
-  /83 ottone spazzolato/ brushed brass

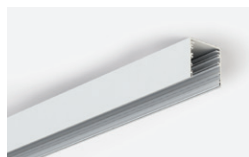

| L.mm | CODE |
|-------|-------------------------|
| 1000 | FT031.1000 /## |
| 2000 | FT031.2000 /## |
| 3000 | FT031.3000 /## |
| ----- | FT031.misura /## |

COPPIA DI TESTATE / COUPLE OF HEADS



| CODE |
|------------------|
| FT040 /## |

GIUNTI LINEARI COPPIA / LINEAR JOINT COUPLE



| CODE |
|---------------|
| LT2482 |

DIFFUSORE POLICARBONATO OPALINO PER VERSIONE STANDARD / OPALINE POLYCARBONATE DIFFUSER FOR STANDARD VERSION

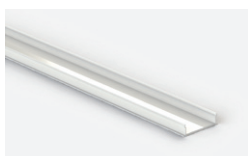

| L.mm | Kg | CODE |
|-------|-------|---------------------|
| 1000 | 0.16 | FT033.1000 |
| 2000 | 0.33 | FT033.2000 |
| 3000 | 0.50 | FT033.3000 |
| ----- | ----- | FT033.misura |

CAVO DI ALIMENTAZIONE COMPLETO DI ROSONE BIANCO / POWER CABLE KIT WITH CEILING CANOPY



| Dim. | CODE | |
|--------|--------------------|-------------------------|
| | L.2000 | L.4000 mm |
| 3X0,75 | LTM048.3/01 | LTM048.3.4000/01 |
| 4X0,75 | LTM048.4/01 | LTM048.4.4000/01 |
| 5X0,75 | LTM048.5/01 | LTM048.5.4000/01 |
| 7X0,75 | LTM048.7/01 | LTM048.7.4000/01 |
| 9X0,75 | LTM048.9/01 | LTM048.9.4000/01 |

CAVI SOSPENSIONE / STEEL SUSPENSION CABLE



| L.mm | Kg | CODE | |
|------|------|---------------|--------------------|
| | | L.2000 | L 4000 mm |
| 2000 | 0.16 | LTM047 | LTM047.4000 |

Uno ogni 2 mt minimo 2 / Suspension cable. One every 2 mt, 2 pieces minimum



ELEMENTI LUMINOSI /LIGHT ELEMENTS P.113

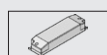

DRIVERS VEDI | SEE P. 447



FIFTY 5

ELEMENTI LUMINOSI/LIGHT ELEMENTS

FIFTY5 STANDARD

FIFTY 5 REGLETTE LED 24W/m / 24W/m LED BATTEN



LED24W/m

| W | Lmm | lm product 3000K | CODE |
|------|------|------------------|--------------------|
| 19,2 | 840 | 1082 | FT152.8 ● ● |
| 25,6 | 1120 | 1442 | FT153.8 ● ● |
| 32 | 1400 | 1803 | FT154.8 ● ● |
| 38,4 | 1680 | 2163 | FT155.8 ● ● |
| 44,8 | 1980 | 2524 | FT156.8 ● ● |
| 51,2 | 2240 | 2884 | FT157.8 ● ● |

Alimentatore incluso | Driver included

FIFTY5PRO

REGLETTE PRO LED LENTE INCLUSA / LED BATTEN PRO LENS INCLUDED



| Led line | | lm prod./beam 3000K | | | | | CODE |
|----------|------|---------------------|-------|------|------|------|----------------------|
| W | L.mm | NR30° | WI60° | DF | SA | DA | |
| 23,4 | 570 | 3177 | 3249 | 3044 | 3146 | 3177 | FT051.9 ○ ● ● |
| 46,8 | 1130 | 6355 | 6497 | 6088 | 6292 | 6355 | FT053.9 ○ ● ● |
| 70,2 | 1690 | 9532 | 9746 | 9131 | 9438 | 9532 | FT055.9 ○ ● ● |

Alimentatore incluso | Driver included

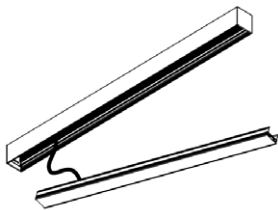

VERSIONI DISPONIBILI/AVAILABLE VERSION

● KELVIN

27 2700K

30 3000K

40 4000K

TW Tunable White Dali*

○ KELVIN

27 2700K

30 3000K

40 4000K

HC Horticulture

TW Tunable White Dali*

* Note: Gli apparecchi con temperatura di colore variabile (Tunable White) vengono forniti comprensivi di alimentatore Dali | The devices with variable color temperature (Tunable White) are supplied with integrated Dali power supply.

● FASCIO/BEAM

NR Narrow 30°

WI Wide 60° UGR<19

DF Diffused

SA Asymmetric

DA Double Asymmetric

COMPOSIZIONE CODICE: xxx.x ● ● ● /##

HOW TO CREATE THE CODE: **F1000.827SD/01**

CODE
F1000.8 ● ● ● /## — finishing
 | | | |
 base code kelvin beam dimmable