

**File H ceiling. Direct and diffused light**

code F1H32.840XD/01



**PRODUCT DESCRIPTION**

Lampada a luce diretta da soffitto indoor realizzata in estruso di alluminio 6060, completo di led; indice di resa cromatica CRI >90. Moduli led professionali assemblati e cablati su dissipatore in estruso di alluminio con riflettore high performance, dotato di molle in acciaio armonico per installazione nel profilo Tools free; cablaggio passante 5 cavi con morsettiere ad innesto rapido; protocollo Dimmable Dali. Lampada con finitura di colore white; in policarbonato con pellicola diffondente. Grado di protezione IP40.

**PRODUCT SPECS**

Installation method	Ceiling surface mounted
Absorbed power	25,6 W
Color temperature	4000K
Color rendering index CRI	>90
Optic	Microprismatic diffuser
Finishing	White
Luminous flux of the product	4087 lm
Luminous efficiency	160 lm/W
MacAdam color tolerance	3
Life time estimate	50000h Ta 25° L80B10
Protocol	Dimmable Dali
Energy efficiency class	E
Dimension	L44.88"
IP Grade	IP40
Power supply	220-240V 50-60Hz

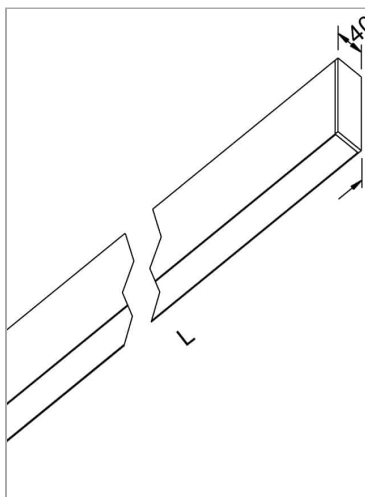

**FILE microprismatic LED**

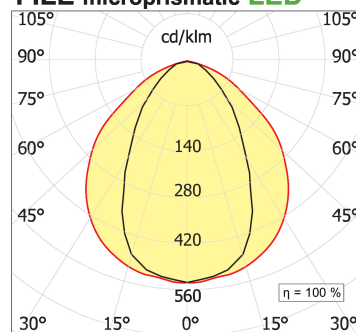

**WEB PAGE**



**ASSEMBLY INSTRUCTIONS**

